

DIN Wickelrohr CSVE

System:	Vinylesterharz
Druckbereich:	bis 20 bar
Steifigkeit:	bis SN 10000
Temperatur:	max. 90°C
Chemieschutzschicht:	2,5 mm Chemieschutzschicht
Norm:	in Anlehnung an DIN 16965 Teil 4
Verbindungsart:	Steckverbindung mit O-Ringen glatte Enden zum Laminieren

DIN Wickelrohr
2,5 mm Chemieschutzschicht

Bezeichnung: DIN Wickelrohr CSVE
 Verbindung: Steckverbindung mit O-Ringen;
 glatte Enden zum Laminieren
 Norm: In Anlehnung an DIN 16965 Teil 4
 Nennweiten: DN 25 - 2000
 Druckstufe: PN 6, PN 10, PN 16, PN 20

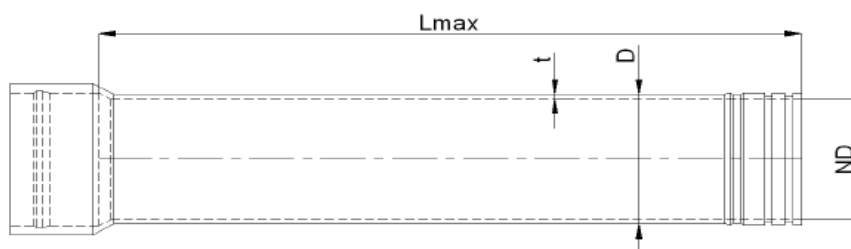

DN	PN6			PN10			PN16			PN20		
	ø D	t	Ge- wicht	ø D	t	Ge- wicht	ø D	t	Ge- wicht	ø D	t	Ge- wicht
[mm]	[mm]	[mm]	[kg/m]	[mm]	[mm]	[kg/m]	[mm]	[mm]	[kg/m]	[mm]	[mm]	[kg/m]
25	33,00	4,0	0,7	33,0	4,0	0,7	33,0	4,0	0,7	33,0	4,0	0,7
40	48,00	4,0	1,0	48,0	4,0	1,0	48,0	4,0	1,0	48,0	4,0	1,0
50	58,00	4,0	1,3	58,0	4,0	1,3	58,0	4,0	1,3	58,0	4,0	1,3
65	73,00	4,0	1,6	73,0	4,0	1,6	73,0	4,0	1,6	73,0	4,0	1,6
80	88,00	4,0	2,0	88,0	4,0	2,0	88,0	4,0	2,0	88,0	4,0	2,0
100	108,00	4,0	2,5	108,0	4,0	2,5	108,0	4,0	2,5	108,0	4,0	2,5
125	133,00	4,0	3,0	133,0	4,0	3,0	133,0	4,0	3,0	133,0	4,0	3,0
150	158,00	4,0	3,6	158,0	4,0	3,6	158,0	4,0	3,6	158,2	4,1	3,7
200	208,00	4,0	4,8	208,0	4,0	4,8	208,6	4,3	5,1	209,8	4,9	5,9
250	258,00	4,0	6,0	258,0	4,0	6,0	259,8	4,9	7,4	261,4	5,7	8,6
300	308,00	4,0	7,2	308,2	4,1	7,4	311,0	5,5	10,0	313,0	6,5	11,8
350	358,00	4,0	8,4	359,0	4,5	9,4	362,4	6,2	13,0	364,6	7,3	15,4
400	408,40	4,2	10,0	409,8	4,9	11,7	413,6	6,8	16,4	416,2	8,1	19,5
450	459,20	4,6	12,3	460,6	5,3	14,2	465,7	7,9	20,2	467,8	8,9	24,1
500	510,00	5,0	14,9	511,4	5,7	17,0	516,2	8,1	24,3	519,4	9,7	29,2
550	560,80	5,4	17,7	562,2	6,1	20,0	567,4	8,7	28,8	571,0	10,5	34,8
600	611,60	5,8	20,7	613,0	6,5	23,3	618,8	9,4	33,8	622,6	11,3	40,8
700	713,20	6,6	27,5	714,6	7,3	30,5	721,4	10,7	44,7	725,8	12,9	54,3

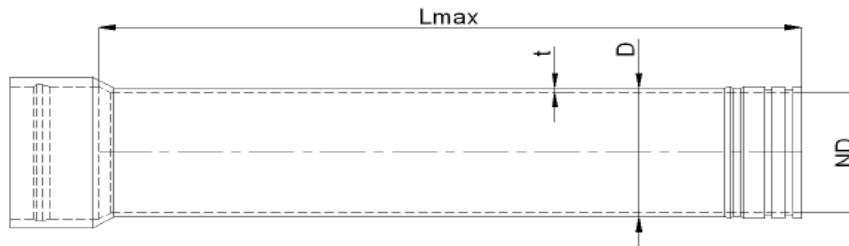

DN	PN6			PN10			PN16			PN20		
	ø D	t	Ge- wicht	ø D	t	Ge- wicht	ø D	t	Ge- wicht	ø D	t	Ge- wicht
[mm]	[mm]	[mm]	[kg/m]	[mm]	[mm]	[kg/m]	[mm]	[mm]	[kg/m]	[mm]	[mm]	[kg/m]
750	764,0	7,0	31,3	765,4	7,7	34,4	772,6	11,3	50,8	777,4	13,7	61,8
800	814,8	7,4	35,3	816,2	8,1	38,6	823,8	11,9	57,3	829,0	14,5	69,8
900	916,4	8,2	44,0	917,8	8,9	47,8	926,4	13,2	71,3	932,2	16,1	87,1
1000	1018,0	9,0	53,6	1019,4	9,7	57,8	1029,0	14,5	86,9	1035,4	17,7	106,4
1100	1119,6	9,8	64,2	1121,0	10,5	68,8	1131,6	15,8	104,0			
1200	1221,2	10,6	75,7	1222,6	11,3	80,8	1234,2	17,1	122,6			
1300	1322,8	11,4	88,2	1324,2	12,1	93,7	1336,6	18,3	142,8			
1400	1424,4	12,2	101,7	1425,8	12,9	107,6	1439,2	19,6	164,5			
1500	1526,0	13,0	116,1	1527,4	13,7	122,4	1541,8	20,9	187,7			
1600	1627,6	13,8	131,5	1629,0	14,5	138,2						
1700	1729,2	14,6	147,8	1730,6	15,3	154,9						
1800	1830,8	15,4	165,0	1832,2	16,1	172,6						
2000	2034,0	17,0	202,4	2035,4	17,7	210,8						

Lieferlänge bis DN 150 = 6 m; Lieferlänge ab DN 150 = 11,7 m

DIN Wickelrohr 2,5 mm Chemieschutzschicht

Bezeichnung: DIN Wickelrohr CSVE
 Verbindung: Steckverbindung mit O-Ringen
 glatte Enden zum Laminieren
 Norm: In Anlehnung an DIN 16965 Teil 4
 Nennweiten: DN 25 - 2000
 Steifigkeit: SN 1250, SN 2500, SN 5000, SN 10000

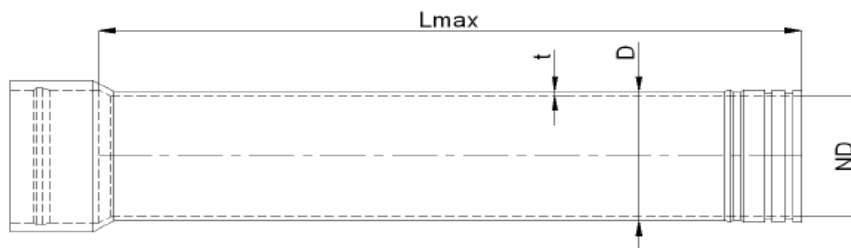

DN	SN 1250			SN 2500			SN 5000			SN 10000		
	ø D	t	Ge- wicht	ø D	t	Ge- wicht	ø D	t	Ge- wicht	ø D	t	Ge- wicht
[mm]	[mm]	[mm]	[kg/m]	[mm]	[mm]	[kg/m]	[mm]	[mm]	[kg/m]	[mm]	[mm]	[kg/m]
25	33,0	4,0	0,7	33,0	4,0	0,7	33,0	4,0	0,7	33,0	4,0	0,7
40	48,0	4,0	1,0	48,0	4,0	1,0	48,0	4,0	1,0	48,0	4,0	1,0
50	58,0	4,0	1,3	58,0	4,0	1,3	58,0	4,0	1,3	58,0	4,0	1,3
65	73,0	4,0	1,6	73,0	4,0	1,6	73,0	4,0	1,6	73,0	4,0	1,6
80	88,0	4,0	2,0	88,0	4,0	2,0	88,0	4,0	2,0	88,0	4,0	2,0
100	108,0	4,0	2,5	108,0	4,0	2,5	108,0	4,0	2,5	108,0	4,0	2,5
125	133,0	4,0	3,0	133,0	4,0	3,0	133,0	4,0	3,0	133,0	4,0	3,0
150	158,0	4,0	3,6	158,0	4,0	3,6	158,0	4,0	3,6	158,0	4,0	3,6
200	208,0	4,0	4,8	208,0	4,0	4,8	208,0	4,0	4,8	208,4	4,2	5,1
250	258,0	4,0	6,0	258,0	4,0	6,0	258,4	4,2	6,3	260,0	5,0	7,5
300	308,0	4,0	7,2	308,0	4,0	7,2	309,6	4,8	8,7	311,6	5,8	10,5
350	358,0	4,0	8,4	359,0	4,5	9,5	360,8	5,4	11,4	363,2	6,6	13,9
400	408,4	4,2	10,0	410,0	5,0	12,0	412,2	6,1	14,6	414,8	7,4	17,8
450	459,2	4,6	12,3	461,0	5,5	14,9	463,4	6,7	18,1	466,4	8,2	22,2
500	510,0	5,0	14,9	512,0	6,0	18,0	514,6	7,3	22,0	518,0	9,0	27,0
550	560,8	5,4	17,7	563,0	6,5	21,5	566,0	8,0	26,3	569,6	9,8	32,4
600	611,6	5,8	20,7	614,0	7,0	25,3	617,2	8,6	31,0	621,2	10,6	38,2
700	713,2	6,6	27,5	716,2	8,1	33,7	719,8	9,9	41,4	724,4	12,2	51,3

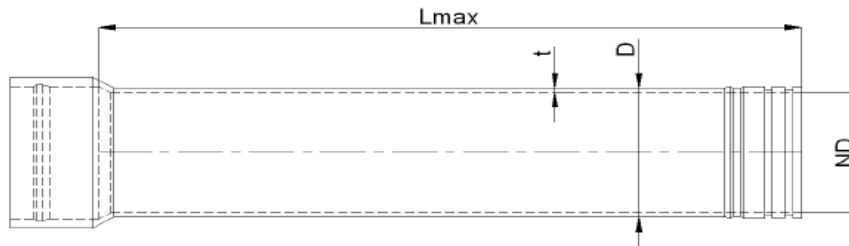

DN	SN 1250			SN 2500			SN 5000			SN 10000		
	ø D	t	Ge- wicht	ø D	t	Ge- wicht	ø D	t	Ge- wicht	ø D	t	Ge- wicht
[mm]	[mm]	[mm]	[kg/m]	[mm]	[mm]	[kg/m]	[mm]	[mm]	[kg/m]	[mm]	[mm]	[kg/m]
750	764,0	7,0	31,3	767,2	8,6	38,3	771,0	10,5	47,2	776,0	13,0	58,6
800	814,8	7,4	35,3	818,2	9,1	43,3	822,4	11,2	53,4	827,6	13,8	66,3
900	916,4	8,2	44,0	920,2	10,1	54,1	924,8	12,4	66,9	930,8	15,4	83,2
1000	1018,0	9,0	53,6	1022,2	11,1	66,1	1027,4	13,7	82,0	1034,0	17,0	102,1
1100	1119,6	9,8	64,2	1124,2	12,1	79,3	1130,0	15,0	98,5	1137,2	18,6	122,8
1200	1221,2	10,6	75,7	1226,2	13,1	93,8	1232,4	16,2	116,6	1240,4	20,2	145,5
1300	1322,8	11,4	88,2	1328,2	14,1	109,4	1335,0	17,5	1336,2	1343,6	21,8	170,1
1400	1424,4	12,2	101,7	1430,2	15,1	126,2	1437,6	18,8	157,3	1446,8	23,4	196,6
1500	1526,0	13,0	116,1	1822,0	161,0	144,3	1540,0	20,0	179,9	1550,0	25,0	225,0
1600				1634,2	17,1	163,5	1642,6	21,3	204,0	1653,2	26,6	255,4
1700				1736,2	18,1	183,9	1745,2	22,6	229,7	1756,4	28,2	287,7
1800				1838,2	19,1	205,6	1847,6	23,8	256,9	1859,6	29,8	321,9
2000				2042,2	21,1	252,4	2052,8	26,4	315,8	2066,0	33,0	396,0

Lieferlänge bis DN 150 = 6 m; Lieferlänge ab DN 150 = 11,7 m

Bogen 90°

Bezeichnung: Bogen 90°
 Verbindung: glatte Enden zum Laminieren
 System: Vinylester
 Nennweiten: DN 25 - 2000
 Druckstufe: PN 6, PN 10, PN 16, PN 20

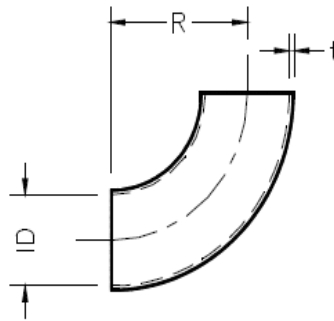

DN	PN6		PN10		PN16		PN20	
	t	R	t	R	t	R	t	R
[mm]	[mm]	[kg/m]	[mm]	[kg/m]	[mm]	[kg/m]	[mm]	[kg/m]
25	4,0	37,5	4,0	37,5	4,0	37,5	4,0	37,5
40	4,0	60,0	4,0	60,0	4,0	60,0	4,0	60,0
50	4,0	75,0	4,0	75,0	4,0	75,0	4,0	75,0
65	4,0	97,5	4,0	97,5	4,0	97,5	4,0	97,5
80	4,0	120,0	4,0	120,0	4,0	120,0	4,3	120,0
100	4,0	150,0	4,0	150,0	4,3	150,0	4,9	150,0
125	4,0	187,5	4,0	187,5	4,9	187,5	5,7	187,5
150	4,0	225,0	4,1	225,0	5,5	225,0	6,5	225,0
200	4,0	300,0	4,9	300,0	6,8	300,0	8,1	300,0
250	4,0	375,0	5,7	375,0	8,1	375,0	9,7	375,0
300	4,0	450,0	6,5	450,0	9,4	450,0	11,3	450,0
350	4,5	525,0	7,3	525,0	10,7	525,0	12,9	525,0
400	5,0	600,0	8,1	600,0	11,9	600,0	14,5	600,0
450	5,5	675,0	8,9	675,0	13,2	675,0	16,1	675,0
500	6,0	750,0	9,7	750,0	14,5	750,0	17,7	750,0
550	6,5	825,0	10,5	825,0	15,8	825,0	19,3	825,0
600	7,0	900,0	11,3	900,0	17,1	900,0	20,9	900,0
700	8,1	1050,0	12,9	1050,0	19,6	1050,0	24,1	1050,0

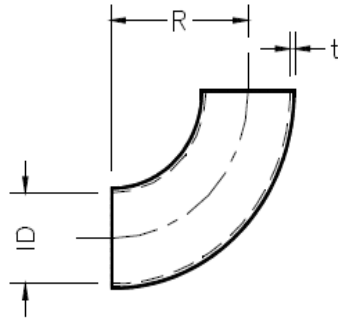

DN [mm]	PN6		PN10		PN16		PN20	
	t [mm]	R [kg/m]	t [mm]	R [kg/m]	t [mm]	R [kg/m]	t [mm]	R [kg/m]
750	8,6	1125,0	13,7	1125,0	20,9	1125,0	25,7	1125,0
800	9,1	1200,0	14,5	1200,0	22,2	1200,0	27,3	1200,0
900	10,1	1350,0	16,1	1350,0	24,7	1350,0		
1000	11,1	1500,0	17,7	1500,0	27,3	1500,0		
1100	12,1	1650,0	19,3	1650,0	29,9	1650,0		
1200	13,1	1800,0	20,9	1800,0	32,4	1800,0		
1300	14,1	1950,0	22,5	1950,0	35,0	1950,0		
1400	15,1	2100,0	24,1	2100,0	37,5	2100,0		
1500	16,1	2250,0	25,7	2250,0	40,1	2250,0		
1600	17,1	2400,0	27,3	2400,0				
1700	18,1	2550,0	28,9	2550,0				
1800	19,1	2700,0	30,5	2700,0				
2000	21,1	3000,0	33,7	3000,0				

Bogen 90°

Bezeichnung: Bogen 90°
 Verbindung: glatte Enden zum Laminieren
 System: Vinylester
 Nennweiten: DN 25 - 2000
 Steifigkeit: SN 1250, SN 2500, SN 5000, SN 10000

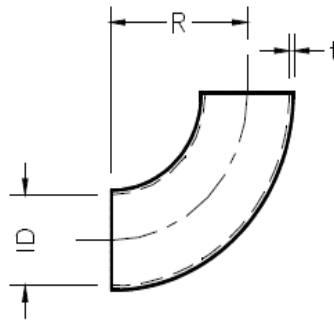

DN	SN 1250		SN 2500		SN 5000		SN 10000	
	t	R	t	R	t	R	t	R
[mm]	[mm]	[kg/m]	[mm]	[kg/m]	[mm]	[kg/m]	[mm]	[kg/m]
25	4,0	37,5	4,0	37,5	4,0	37,5	4,0	37,5
40	4,0	60,0	4,0	60,0	4,0	60,0	4,0	60,0
50	4,0	75,0	4,0	75,0	4,0	75,0	4,0	75,0
65	4,0	97,5	4,0	97,5	4,0	97,5	4,0	97,5
80	4,0	120,0	4,0	120,0	4,0	120,0	4,0	120,0
100	4,0	150,0	4,0	150,0	4,0	150,0	4,0	150,0
125	4,0	187,5	4,0	187,5	4,0	187,5	4,0	187,5
150	4,0	225,0	4,0	225,0	4,0	225,0	4,0	225,0
200	4,0	300,0	4,0	300,0	4,2	300,0	5,0	300,0
250	4,0	375,0	4,2	375,0	5,0	375,0	6,0	375,0
300	4,0	450,0	4,8	450,0	5,8	450,0	7,0	450,0
350	4,5	525,0	5,4	525,0	6,6	525,0	8,1	525,0
400	5,0	600,0	6,1	600,0	7,4	600,0	9,1	600,0
450	5,5	675,0	6,7	675,0	8,2	675,0	10,1	675,0
500	6,0	750,0	7,3	750,0	9,0	750,0	11,1	750,0
550	6,5	825,0	8,0	825,0	9,8	825,0	12,1	825,0
600	7,0	900,0	8,6	900,0	10,6	900,0	13,1	900,0
700	8,1	1050,0	9,9	1050,0	12,2	1050,0	15,1	1050,0

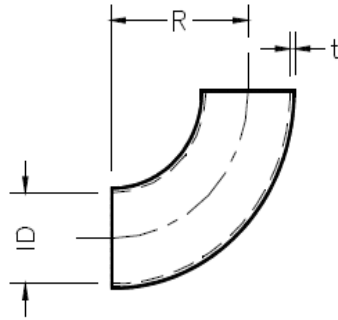

DN [mm]	SN 1250		SN 2500		SN 5000		SN 10000	
	t [mm]	R [kg/m]	t [mm]	R [kg/m]	t [mm]	R [kg/m]	t [mm]	R [kg/m]
750	8,6	1125,0	10,5	1125,0	12,2	1050,0	16,1	1125,0
800	9,1	1200,0	11,2	1200,0	13,0	1125,0	17,1	1200,0
900	10,1	1350,0	12,4	1350,0	13,8	1200,0	19,1	1350,0
1000	11,1	1500,0	13,7	1500,0	15,4	1350,0	21,1	1500,0
1100	12,1	1650,0	15,0	1650,0	17,0	1500,0	23,2	1650,0
1200	13,1	1800,0	16,2	1800,0	18,6	1650,0	25,2	1800,0
1300	14,1	1950,0	17,5	1950,0	20,2	1800,0	27,2	1950,0
1400	15,1	2100,0	18,8	2100,0	21,8	1950,0	29,2	2100,0
1500	16,1	2250,0	20,0	2250,0	23,4	2100,0	31,2	2250,0
1600			21,3	2400,0	25,0	2250,0	33,2	2400,0
1700			22,6	2550,0	26,6	2400,0	35,2	2550,0
1800			23,8	2700,0	28,2	2550,0	37,3	2700,0
2000			26,4	3000,0	29,8	2700,0	41,3	3000,0

Reduzierung konzentrisch

Bezeichnung: Reduzierung konzentrisch
 Verbindung: glatte Enden zum Laminieren
 System: Vinylester
 Nennweiten: DN 25 - 2000
 Druckstufe: PN 6, PN 10, PN 16, PN 20

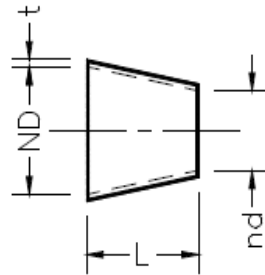

		PN6		PN10		PN16		PN20	
DN	dn	t	R	t	R	t	R	t	R
[mm]	[mm]	[mm]	[kg/m]	[mm]	[kg/m]	[mm]	[kg/m]	[mm]	[kg/m]
40	25	4,0	38	4,0	38	4,0	38	4,0	38
50	25	4,0	63	4,0	63	4,0	63	4,0	63
50	40	4,0	25	4,0	25	4,0	25	4,0	25
65	25	4,0	100	4,0	100	4,0	100	4,0	100
65	40	4,0	63	4,0	63	4,0	63	4,0	63
65	50	4,0	38	4,0	38	4,0	38	4,0	38
80	40	4,0	100	4,0	100	4,0	100	4,3	100
80	50	4,0	75	4,0	75	4,0	75	4,3	75
80	65	4,0	38	4,0	38	4,0	38	4,3	38
100	50	4,0	125	4,0	125	4,3	125	4,9	125
100	65	4,0	88	4,0	88	4,3	88	4,9	88
100	80	4,0	50	4,0	50	4,3	50	4,9	50
125	65	4,0	150	4,0	150	4,9	150	5,7	150
125	80	4,0	113	4,0	113	4,9	113	5,7	113
125	100	4,0	63	4,0	63	4,9	63	5,7	63
150	80	4,0	175	4,1	175	5,5	175	6,5	175
150	100	4,0	125	4,1	125	5,5	125	6,5	125
150	125	4,0	63	4,1	63	5,5	63	6,5	63
200	100	4,0	250	4,9	250	6,8	250	8,1	250

		PN6		PN10		PN16		PN20	
DN	dn	t	R	t	R	t	R	t	R
[mm]	[mm]	[mm]	[kg/m]	[mm]	[kg/m]	[mm]	[kg/m]	[mm]	[kg/m]
200	125	4,0	188	4,9	188	6,8	188	8,1	188
200	150	4,0	125	4,9	125	6,8	125	8,1	125
250	125	4,0	313	5,7	313	8,1	313	9,7	313
250	150	4,0	250	5,7	250	8,1	250	9,7	250
250	200	4,0	125	5,7	125	8,1	125	9,7	125
300	150	4,0	375	6,5	375	9,4	375	11,3	375
300	200	4,0	250	6,5	250	9,4	250	11,3	250
300	250	4,0	125	6,5	125	9,4	125	11,3	125
350	200	4,5	375	7,3	375	10,7	375	12,9	375
350	250	4,5	250	7,3	250	10,7	250	12,9	250
350	300	4,5	125	7,3	125	10,7	125	12,9	125
400	250	5,0	375	8,1	375	11,9	375	14,5	375
400	300	5,0	250	8,1	250	11,9	250	14,5	250
400	350	5,0	125	8,1	125	11,9	125	14,5	125
450	300	5,5	375	8,9	375	13,2	375	16,1	375
450	350	5,5	250	8,9	250	13,2	250	16,1	250
450	400	5,5	125	8,9	125	13,2	125	16,1	125
500	350	6,0	375	9,7	375	14,5	375	17,7	375
500	400	6,0	250	9,7	250	14,5	250	17,7	250
500	450	6,0	125	9,7	125	14,5	125	17,7	125
550	400	6,5	375	10,5	375	15,8	375	19,3	375
550	450	6,5	250	10,5	250	15,8	250	19,3	250
550	500	6,5	125	10,5	125	15,8	125	19,3	125
600	450	7,0	375	11,3	375	17,1	375	20,9	375
600	500	7,0	250	11,3	250	17,1	250	20,9	250
600	550	7,0	125	11,3	125	17,1	125	20,9	125
700	500	8,1	500	12,9	500	19,6	500	24,1	500
700	550	8,1	375	12,9	375	19,6	375	24,1	375
700	600	8,1	250	12,9	250	19,6	250	24,1	250
750	550	8,6	500	13,7	500	20,9	500	25,7	500
750	600	8,6	375	13,7	375	20,9	375	25,7	375
750	700	8,6	125	13,7	125	20,9	125	25,7	125
800	600	9,1	500	14,5	500	22,2	500	27,3	500
800	700	9,1	250	14,5	250	22,2	250	27,3	250
800	750	9,1	125	14,5	125	22,2	125	27,3	125
900	700	10,1	500	16,1	500	24,7	500		

		PN6		PN10		PN16		PN20	
DN	dn	t	R	t	R	t	R	t	R
[mm]	[mm]	[mm]	[kg/m]	[mm]	[kg/m]	[mm]	[kg/m]	[mm]	[kg/m]
900	750	10,1	375	16,1	375	24,7	375		
900	800	10,1	250	16,1	250	24,7	250		
1000	750	11,1	625	17,7	625	27,3	625		
1000	800	11,1	500	17,7	500	27,3	500		
1000	900	11,1	250	17,7	250	27,3	250		
1100	800	12,1	750	19,3	750	29,9	750		
1100	900	12,1	500	19,3	500	29,9	500		
1100	1000	12,1	250	19,3	250	29,9	250		
1200	900	13,1	750	20,9	750	32,4	750		
1200	1000	13,1	500	20,9	500	32,4	500		
1200	1100	13,1	250	20,9	250	32,4	250		
1300	1000	14,1	750	22,5	750	35,0	750		
1300	1100	14,1	500	22,5	500	35,0	500		
1300	1200	14,1	250	22,5	250	35,0	250		
1400	1100	15,1	750	24,1	750	37,5	750		
1400	1200	15,1	500	24,1	500	37,5	500		
1400	1300	15,1	250	24,1	250	37,5	250		
1500	1200	16,1	750	25,7	750	40,1	750		
1500	1300	16,1	500	25,7	500	40,1	500		
1500	1400	16,1	250	25,7	250	40,1	250		
1600	1300	17,1	750	27,3	750				
1600	1400	17,1	500	27,3	500				
1600	1500	17,1	250	27,3	250				
1700	1400	18,1	750	28,9	750				
1700	1500	18,1	500	28,9	500				
1700	1600	18,1	250	28,9	250				
1800	1500	19,1	750	30,5	750				
1800	1600	19,1	500	30,5	500				
1800	1700	19,1	250	30,5	250				
2000	1600	21,1	1000	33,7	1000				
2000	1700	21,1	750	33,7	750				
2000	1800	21,1	500	33,7	500				

Reduzierung konzentrisch

Bezeichnung: Reduzierung konzentrisch
 Verbindung: glatte Enden zum Laminieren
 System: Vinylester
 Nennweiten: DN 25 - 2000
 Steifigkeit: SN 1250, SN 2500, SN 5000, SN 10000

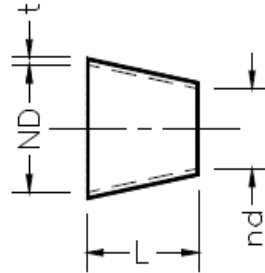

		SN 1250		SN 2500		SN 5000		SN 10000	
DN [mm]	dn [mm]	t [mm]	R [kg/m]	t [mm]	R [kg/m]	t [mm]	R [kg/m]	t [mm]	R [kg/m]
40	25	4,0	38	4,0	38	4,0	38	4,0	38
50	25	4,0	63	4,0	63	4,0	63	4,0	63
50	40	4,0	25	4,0	25	4,0	25	4,0	25
65	25	4,0	100	4,0	100	4,0	100	4,0	100
65	40	4,0	63	4,0	63	4,0	63	4,0	63
65	50	4,0	38	4,0	38	4,0	38	4,0	38
80	40	4,0	100	4,0	100	4,0	100	4,0	100
80	50	4,0	75	4,0	75	4,0	75	4,0	75
80	65	4,0	38	4,0	38	4,0	38	4,0	38
100	50	4,0	125	4,0	125	4,0	125	4,0	125
100	65	4,0	88	4,0	88	4,0	88	4,0	88
100	80	4,0	50	4,0	50	4,0	50	4,0	50
125	65	4,0	150	4,0	150	4,0	150	4,0	150
125	80	4,0	113	4,0	113	4,0	113	4,0	113
125	100	4,0	63	4,0	63	4,0	63	4,0	63
150	80	4,0	175	4,0	175	4,0	175	4,0	175
150	100	4,0	125	4,0	125	4,0	125	4,0	125
150	125	4,0	63	4,0	63	4,0	63	4,0	63
200	100	4,0	250	4,0	250	4,2	250	5,0	250

		SN 1250		SN 2500		SN 5000		SN 10000	
DN	dn	t	R	t	R	t	R	t	R
[mm]	[mm]	[mm]	[kg/m]	[mm]	[kg/m]	[mm]	[kg/m]	[mm]	[kg/m]
200	125	4,0	188	4,0	188	4,2	188	5,0	188
200	150	4,0	125	4,0	125	4,2	125	5,0	125
250	125	4,0	313	4,2	313	5,0	313	6,0	313
250	150	4,0	250	4,2	250	5,0	250	6,0	250
250	200	4,0	125	4,2	125	5,0	125	6,0	125
300	150	4,0	375	4,8	375	5,8	375	7,0	375
300	200	4,0	250	4,8	250	5,8	250	7,0	250
300	250	4,0	125	4,8	125	5,8	125	7,0	125
350	200	4,5	375	5,4	375	6,6	375	8,1	375
350	250	4,5	250	5,4	250	6,6	250	8,1	250
350	300	4,5	125	5,4	125	6,6	125	8,1	125
400	250	5,0	375	6,1	375	7,4	375	9,1	375
400	300	5,0	250	6,1	250	7,4	250	9,1	250
400	350	5,0	125	6,1	125	7,4	125	9,1	125
450	300	5,5	375	6,7	375	8,2	375	10,1	375
450	350	5,5	250	6,7	250	8,2	250	10,1	250
450	400	5,5	125	6,7	125	8,2	125	10,1	125
500	350	6,0	375	7,3	375	9,0	375	11,1	375
500	400	6,0	250	7,3	250	9,0	250	11,1	250
500	450	6,0	125	7,3	125	9,0	125	11,1	125
550	400	6,5	375	8,0	375	9,8	375	12,1	375
550	450	6,5	250	8,0	250	9,8	250	12,1	250
550	500	6,5	125	8,0	125	9,8	125	12,1	125
600	450	7,0	375	8,6	375	10,6	375	13,1	375
600	500	7,0	250	8,6	250	10,6	250	13,1	250
600	550	7,0	125	8,6	125	10,6	125	13,1	125
700	500	8,1	500	9,9	500	12,2	500	15,1	500
700	550	8,1	375	9,9	375	12,2	375	15,1	375
700	600	8,1	250	9,9	250	12,2	250	15,1	250
750	550	8,6	500	10,5	500	13,0	500	16,1	500
750	600	8,6	375	10,5	375	13,0	375	16,1	375
750	700	8,6	125	10,5	125	13,0	125	16,1	125
800	600	9,1	500	11,2	500	13,8	500	17,1	500
800	700	9,1	250	11,2	250	13,8	250	17,1	250
800	750	9,1	125	11,2	125	13,8	125	17,1	125
900	700	10,1	500	12,4	500	15,4	500	19,1	500

		SN 1250		SN 2500		SN 5000		SN 10000	
DN	dn	t	R	t	R	t	R	t	R
[mm]	[mm]	[mm]	[kg/m]	[mm]	[kg/m]	[mm]	[kg/m]	[mm]	[kg/m]
900	750	10,1	375	12,4	375	15,4	375	19,1	375
900	800	10,1	250	12,4	250	15,4	250	19,1	250
1000	750	11,1	625	13,7	625	17,0	625	21,1	625
1000	800	11,1	500	13,7	500	17,0	500	21,1	500
1000	900	11,1	250	13,7	250	17,0	250	21,1	250
1100	800	12,1	750	15,0	750	18,6	750	23,2	750
1100	900	12,1	500	15,0	500	18,6	500	23,2	500
1100	1000	12,1	250	15,0	250	18,6	250	23,2	250
1200	900	13,1	750	16,2	750	20,2	750	25,2	750
1200	1000	13,1	500	16,2	500	20,2	500	25,2	500
1200	1100	13,1	250	16,2	250	20,2	250	25,2	250
1300	1000	14,1	750	17,5	750	21,8	750	27,2	750
1300	1100	14,1	500	17,5	500	21,8	500	27,2	500
1300	1200	14,1	250	17,5	250	21,8	250	27,2	250
1400	1100	15,1	750	18,8	750	23,4	750	29,2	750
1400	1200	15,1	500	18,8	500	23,4	500	29,2	500
1400	1300	15,1	250	18,8	250	23,4	250	29,2	250
1500	1200	16,1	750	20,0	750	25,0	750	31,2	750
1500	1300	16,1	500	20,0	500	25,0	500	31,2	500
1500	1400	16,1	250	20,0	250	25,0	250	31,2	250
1600	1300			21,3	750	26,6	750	33,2	750
1600	1400			21,3	500	26,6	500	33,2	500
1600	1500			21,3	250	26,6	250	33,2	250
1700	1400			22,6	750	28,2	750	35,2	750
1700	1500			22,6	500	28,2	500	35,2	500
1700	1600			22,6	250	28,2	250	35,2	250
1800	1500			23,8	750	29,8	750	37,3	750
1800	1600			23,8	500	29,8	500	37,3	500
1800	1700			23,8	250	29,8	250	37,3	250
2000	1600			26,4	1000	33,0	1000	41,3	1000
2000	1700			26,4	750	33,0	750	41,3	750
2000	1800			26,4	500	33,0	500	41,3	500

Reduzierung exzentrisch

Bezeichnung: Reduzierung exzentrisch
 Verbindung: glatte Enden zum Laminieren
 System: Vinylester
 Nennweiten: DN 25 - 2000
 Druckstufe: PN 6, PN 10, PN 16, PN 20

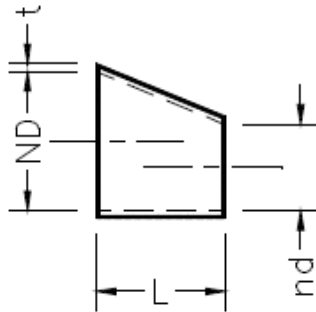

		PN6		PN10		PN16		PN20	
DN	dn	t	R	t	R	t	R	t	R
[mm]	[mm]	[mm]	[kg/m]	[mm]	[kg/m]	[mm]	[kg/m]	[mm]	[kg/m]
40	25	4,0	38	4,0	38	4,0	38	4,0	38
50	25	4,0	63	4,0	63	4,0	63	4,0	63
50	40	4,0	25	4,0	25	4,0	25	4,0	25
65	25	4,0	100	4,0	100	4,0	100	4,0	100
65	40	4,0	63	4,0	63	4,0	63	4,0	63
65	50	4,0	38	4,0	38	4,0	38	4,0	38
80	40	4,0	100	4,0	100	4,0	100	4,3	100
80	50	4,0	75	4,0	75	4,0	75	4,3	75
80	65	4,0	38	4,0	38	4,0	38	4,3	38
100	50	4,0	125	4,0	125	4,3	125	4,9	125
100	65	4,0	88	4,0	88	4,3	88	4,9	88
100	80	4,0	50	4,0	50	4,3	50	4,9	50
125	65	4,0	150	4,0	150	4,9	150	5,7	150
125	80	4,0	113	4,0	113	4,9	113	5,7	113
125	100	4,0	63	4,0	63	4,9	63	5,7	63
150	80	4,0	175	4,1	175	5,5	175	6,5	175
150	100	4,0	125	4,1	125	5,5	125	6,5	125
150	125	4,0	63	4,1	63	5,5	63	6,5	63
200	100	4,0	250	4,9	250	6,8	250	8,1	250

		PN6		PN10		PN16		PN20	
DN	dn	t	R	t	R	t	R	t	R
[mm]	[mm]	[mm]	[kg/m]	[mm]	[kg/m]	[mm]	[kg/m]	[mm]	[kg/m]
200	125	4,0	188	4,9	188	6,8	188	8,1	188
200	150	4,0	125	4,9	125	6,8	125	8,1	125
250	125	4,0	313	5,7	313	8,1	313	9,7	313
250	150	4,0	250	5,7	250	8,1	250	9,7	250
250	200	4,0	125	5,7	125	8,1	125	9,7	125
300	150	4,0	375	6,5	375	9,4	375	11,3	375
300	200	4,0	250	6,5	250	9,4	250	11,3	250
300	250	4,0	125	6,5	125	9,4	125	11,3	125
350	200	4,5	375	7,3	375	10,7	375	12,9	375
350	250	4,5	250	7,3	250	10,7	250	12,9	250
350	300	4,5	125	7,3	125	10,7	125	12,9	125
400	250	5,0	375	8,1	375	11,9	375	14,5	375
400	300	5,0	250	8,1	250	11,9	250	14,5	250
400	350	5,0	125	8,1	125	11,9	125	14,5	125
450	300	5,5	375	8,9	375	13,2	375	16,1	375
450	350	5,5	250	8,9	250	13,2	250	16,1	250
450	400	5,5	125	8,9	125	13,2	125	16,1	125
500	350	6,0	375	9,7	375	14,5	375	17,7	375
500	400	6,0	250	9,7	250	14,5	250	17,7	250
500	450	6,0	125	9,7	125	14,5	125	17,7	125
550	400	6,5	375	10,5	375	15,8	375	19,3	375
550	450	6,5	250	10,5	250	15,8	250	19,3	250
550	500	6,5	125	10,5	125	15,8	125	19,3	125
600	450	7,0	375	11,3	375	17,1	375	20,9	375
600	500	7,0	250	11,3	250	17,1	250	20,9	250
600	550	7,0	125	11,3	125	17,1	125	20,9	125
700	500	8,1	500	12,9	500	19,6	500	24,1	500
700	550	8,1	375	12,9	375	19,6	375	24,1	375
700	600	8,1	250	12,9	250	19,6	250	24,1	250
750	550	8,6	500	13,7	500	20,9	500	25,7	500
750	600	8,6	375	13,7	375	20,9	375	25,7	375
750	700	8,6	125	13,7	125	20,9	125	25,7	125
800	600	9,1	500	14,5	500	22,2	500	27,3	500
800	700	9,1	250	14,5	250	22,2	250	27,3	250
800	750	9,1	125	14,5	125	22,2	125	27,3	125
900	700	10,1	500	16,1	500	24,7	500		

		PN6		PN10		PN16		PN20	
DN	dn	t	R	t	R	t	R	t	R
[mm]	[mm]	[mm]	[kg/m]	[mm]	[kg/m]	[mm]	[kg/m]	[mm]	[kg/m]
900	750	10,1	375	16,1	375	24,7	375		
900	800	10,1	250	16,1	250	24,7	250		
1000	750	11,1	625	17,7	625	27,3	625		
1000	800	11,1	500	17,7	500	27,3	500		
1000	900	11,1	250	17,7	250	27,3	250		
1100	800	12,1	750	19,3	750	29,9	750		
1100	900	12,1	500	19,3	500	29,9	500		
1100	1000	12,1	250	19,3	250	29,9	250		
1200	900	13,1	750	20,9	750	32,4	750		
1200	1000	13,1	500	20,9	500	32,4	500		
1200	1100	13,1	250	20,9	250	32,4	250		
1300	1000	14,1	750	22,5	750	35,0	750		
1300	1100	14,1	500	22,5	500	35,0	500		
1300	1200	14,1	250	22,5	250	35,0	250		
1400	1100	15,1	750	24,1	750	37,5	750		
1400	1200	15,1	500	24,1	500	37,5	500		
1400	1300	15,1	250	24,1	250	37,5	250		
1500	1200	16,1	750	25,7	750	40,1	750		
1500	1300	16,1	500	25,7	500	40,1	500		
1500	1400	16,1	250	25,7	250	40,1	250		
1600	1300	17,1	750	27,3	750				
1600	1400	17,1	500	27,3	500				
1600	1500	17,1	250	27,3	250				
1700	1400	18,1	750	28,9	750				
1700	1500	18,1	500	28,9	500				
1700	1600	18,1	250	28,9	250				
1800	1500	19,1	750	30,5	750				
1800	1600	19,1	500	30,5	500				
1800	1700	19,1	250	30,5	250				
2000	1600	21,1	1000	33,7	1000				
2000	1700	21,1	750	33,7	750				
2000	1800	21,1	500	33,7	500				

Reduzierung exzentrisch

Bezeichnung: Reduzierung exzentrisch
 Verbindung: glatte Enden zum Laminieren
 System: Vinylester
 Nennweiten: DN 25 - 2000
 Steifigkeit: SN 1250, SN 2500, SN 5000, SN 10000

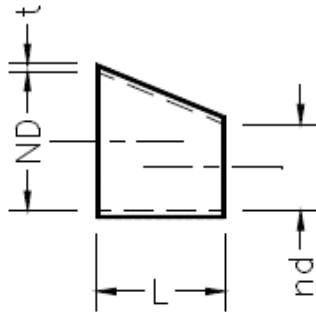

		SN 1250		SN 2500		SN 5000		SN 10000	
DN	dn	t	R	t	R	t	R	t	R
[mm]	[mm]	[mm]	[kg/m]	[mm]	[kg/m]	[mm]	[kg/m]	[mm]	[kg/m]
40	25	4,0	38	4,0	38	4,0	38	4,0	38
50	25	4,0	63	4,0	63	4,0	63	4,0	63
50	40	4,0	25	4,0	25	4,0	25	4,0	25
65	25	4,0	100	4,0	100	4,0	100	4,0	100
65	40	4,0	63	4,0	63	4,0	63	4,0	63
65	50	4,0	38	4,0	38	4,0	38	4,0	38
80	40	4,0	100	4,0	100	4,0	100	4,0	100
80	50	4,0	75	4,0	75	4,0	75	4,0	75
80	65	4,0	38	4,0	38	4,0	38	4,0	38
100	50	4,0	125	4,0	125	4,0	125	4,0	125
100	65	4,0	88	4,0	88	4,0	88	4,0	88
100	80	4,0	50	4,0	50	4,0	50	4,0	50
125	65	4,0	150	4,0	150	4,0	150	4,0	150
125	80	4,0	113	4,0	113	4,0	113	4,0	113
125	100	4,0	63	4,0	63	4,0	63	4,0	63
150	80	4,0	175	4,0	175	4,0	175	4,0	175
150	100	4,0	125	4,0	125	4,0	125	4,0	125
150	125	4,0	63	4,0	63	4,0	63	4,0	63
200	100	4,0	250	4,0	250	4,2	250	5,0	250

		SN 1250		SN 2500		SN 5000		SN 10000	
DN	dn	t	R	t	R	t	R	t	R
[mm]	[mm]	[mm]	[kg/m]	[mm]	[kg/m]	[mm]	[kg/m]	[mm]	[kg/m]
200	125	4,0	188	4,0	188	4,2	188	5,0	188
200	150	4,0	125	4,0	125	4,2	125	5,0	125
250	125	4,0	313	4,2	313	5,0	313	6,0	313
250	150	4,0	250	4,2	250	5,0	250	6,0	250
250	200	4,0	125	4,2	125	5,0	125	6,0	125
300	150	4,0	375	4,8	375	5,8	375	7,0	375
300	200	4,0	250	4,8	250	5,8	250	7,0	250
300	250	4,0	125	4,8	125	5,8	125	7,0	125
350	200	4,5	375	5,4	375	6,6	375	8,1	375
350	250	4,5	250	5,4	250	6,6	250	8,1	250
350	300	4,5	125	5,4	125	6,6	125	8,1	125
400	250	5,0	375	6,1	375	7,4	375	9,1	375
400	300	5,0	250	6,1	250	7,4	250	9,1	250
400	350	5,0	125	6,1	125	7,4	125	9,1	125
450	300	5,5	375	6,7	375	8,2	375	10,1	375
450	350	5,5	250	6,7	250	8,2	250	10,1	250
450	400	5,5	125	6,7	125	8,2	125	10,1	125
500	350	6,0	375	7,3	375	9,0	375	11,1	375
500	400	6,0	250	7,3	250	9,0	250	11,1	250
500	450	6,0	125	7,3	125	9,0	125	11,1	125
550	400	6,5	375	8,0	375	9,8	375	12,1	375
550	450	6,5	250	8,0	250	9,8	250	12,1	250
550	500	6,5	125	8,0	125	9,8	125	12,1	125
600	450	7,0	375	8,6	375	10,6	375	13,1	375
600	500	7,0	250	8,6	250	10,6	250	13,1	250
600	550	7,0	125	8,6	125	10,6	125	13,1	125
700	500	8,1	500	9,9	500	12,2	500	15,1	500
700	550	8,1	375	9,9	375	12,2	375	15,1	375
700	600	8,1	250	9,9	250	12,2	250	15,1	250
750	550	8,6	500	10,5	500	13,0	500	16,1	500
750	600	8,6	375	10,5	375	13,0	375	16,1	375
750	700	8,6	125	10,5	125	13,0	125	16,1	125
800	600	9,1	500	11,2	500	13,8	500	17,1	500
800	700	9,1	250	11,2	250	13,8	250	17,1	250
800	750	9,1	125	11,2	125	13,8	125	17,1	125
900	700	10,1	500	12,4	500	15,4	500	19,1	500

		SN 1250		SN 2500		SN 5000		SN 10000	
DN	dn	t	R	t	R	t	R	t	R
[mm]	[mm]	[mm]	[kg/m]	[mm]	[kg/m]	[mm]	[kg/m]	[mm]	[kg/m]
900	750	10,1	375	12,4	375	15,4	375	19,1	375
900	800	10,1	250	12,4	250	15,4	250	19,1	250
1000	750	11,1	625	13,7	625	17,0	625	21,1	625
1000	800	11,1	500	13,7	500	17,0	500	21,1	500
1000	900	11,1	250	13,7	250	17,0	250	21,1	250
1100	800	12,1	750	15,0	750	18,6	750	23,2	750
1100	900	12,1	500	15,0	500	18,6	500	23,2	500
1100	1000	12,1	250	15,0	250	18,6	250	23,2	250
1200	900	13,1	750	16,2	750	20,2	750	25,2	750
1200	1000	13,1	500	16,2	500	20,2	500	25,2	500
1200	1100	13,1	250	16,2	250	20,2	250	25,2	250
1300	1000	14,1	750	17,5	750	21,8	750	27,2	750
1300	1100	14,1	500	17,5	500	21,8	500	27,2	500
1300	1200	14,1	250	17,5	250	21,8	250	27,2	250
1400	1100	15,1	750	18,8	750	23,4	750	29,2	750
1400	1200	15,1	500	18,8	500	23,4	500	29,2	500
1400	1300	15,1	250	18,8	250	23,4	250	29,2	250
1500	1200	16,1	750	20,0	750	25,0	750	31,2	750
1500	1300	16,1	500	20,0	500	25,0	500	31,2	500
1500	1400	16,1	250	20,0	250	25,0	250	31,2	250
1600	1300			21,3	750	26,6	750	33,2	750
1600	1400			21,3	500	26,6	500	33,2	500
1600	1500			21,3	250	26,6	250	33,2	250
1700	1400			22,6	750	28,2	750	35,2	750
1700	1500			22,6	500	28,2	500	35,2	500
1700	1600			22,6	250	28,2	250	35,2	250
1800	1500			23,8	750	29,8	750	37,3	750
1800	1600			23,8	500	29,8	500	37,3	500
1800	1700			23,8	250	29,8	250	37,3	250
2000	1600			26,4	1000	33,0	1000	41,3	1000
2000	1700			26,4	750	33,0	750	41,3	750
2000	1800			26,4	500	33,0	500	41,3	500

Flansch

Bezeichnung: Flansch
 Norm: DIN, ANSI (nach Kundenwunsch)
 System: Vinylester
 Nennweiten: DN 25 - 2000
 Druckstufe: PN 6, PN 10, PN 16, PN 20

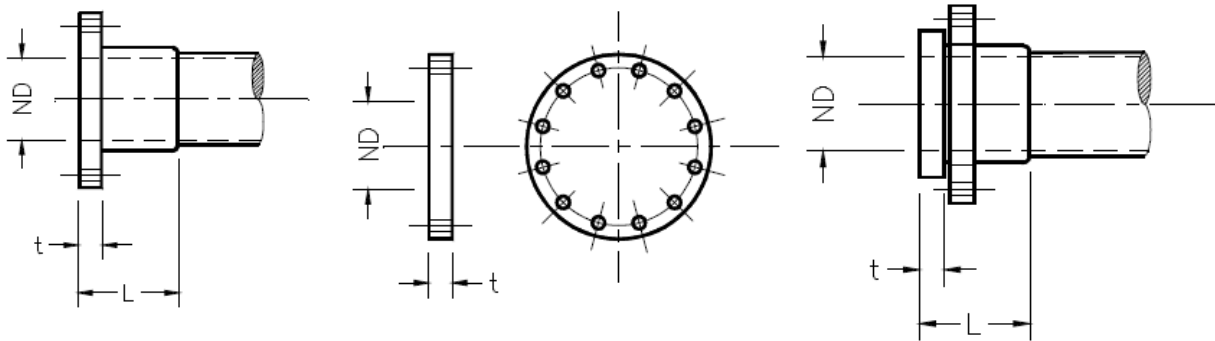

DN [mm]	PN6		PN10		PN16		PN20	
	t [mm]	L [mm]	t [mm]	L [mm]	t [mm]	L [mm]	t [mm]	L [mm]
25	20	100	20	100	20	100	20	100
40	20	100	20	100	20	100	20	100
50	20	100	20	100	20	100	20	100
65	20	100	20	100	20	100	20	100
80	25	100	25	100	25	100	25	100
100	25	100	25	100	25	100	25	100
125	25	100	25	100	25	100	25	100
150	25	100	25	100	25	100	30	120
200	25	100	25	100	30	120	35	140
250	25	100	25	100	35	140	45	180
300	25	100	30	120	45	180	55	220
350	25	100	30	120	50	200	65	260
400	25	100	35	140	60	240	70	280
450	30	120	40	160	65	260	80	320
500	30	120	45	180	70	280	90	360
550	35	1140	50	200	80	320	100	400
600	35	140	55	220	85	340	105	420
700	45	180	60	240	100	400	125	500

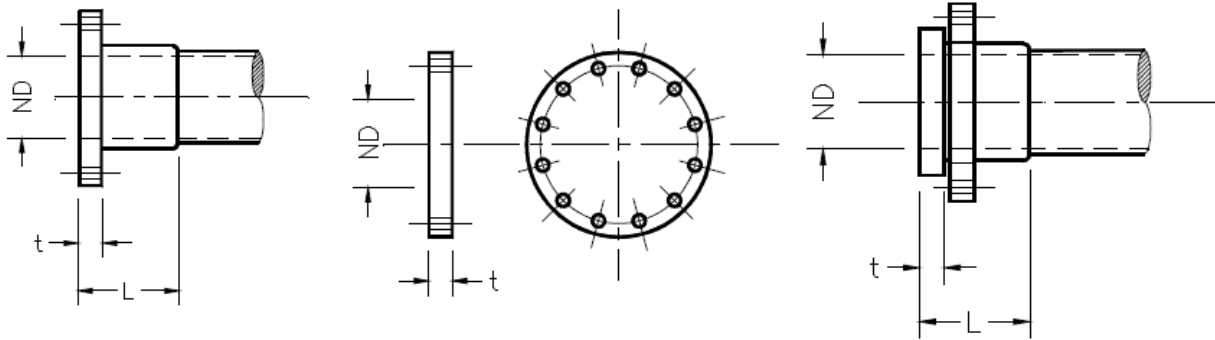

DN [mm]	PN6		PN10		PN16		PN20	
	t [mm]	L [mm]	t [mm]	L [mm]	t [mm]	L [mm]	t [mm]	L [mm]
750	45	180	65	260	105	420	135	540
800	50	200	70	280	115	460	140	560
900	55	220	80	320	125	500		
1000	60	240	90	360	140	560		
1100	65	260	95	380	155	620		
1200	70	280	105	420	170	680		
1300	75	300	115	460	180	720		
1400	80	320	120	480	190	760		
1500	90	360	130	520	210	840		
1600	95	380	140	560				
1700	100	400	150	600				
1800	105	420	155	620				
2000	115	460	170	680				

Kappe

Bezeichnung: Kappe
 Verbindung: glatte Enden zum Laminieren
 System: Vinylester
 Nennweiten: DN 25 - 2000
 Druckstufe: PN 6, PN 10, PN 16, PN 20

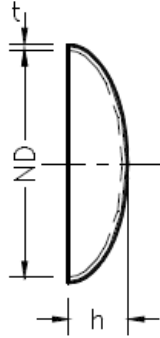

DN	PN6		PN10		PN16		PN20	
	t	h	t	h	t	h	t	h
[mm]	[mm]	[kg/m]	[mm]	[kg/m]	[mm]	[kg/m]	[mm]	[kg/m]
25	4,0	6,3	4,0	6,3	4,0	6,3	4,0	6,3
40	4,0	10,0	4,0	10,0	4,0	10,0	4,0	10,0
50	4,0	12,5	4,0	12,5	4,0	12,5	4,0	12,5
65	4,0	16,3	4,0	16,3	4,0	16,3	4,0	16,3
80	4,0	20,0	4,0	20,0	4,0	20,0	4,3	20,0
100	4,0	25,0	4,0	25,0	4,3	25,0	4,9	25,0
125	4,0	31,3	4,0	31,3	4,9	31,3	5,7	31,3
150	4,0	37,5	4,1	37,5	5,5	37,5	6,5	37,5
200	4,0	50,0	4,9	50,0	6,8	50,0	8,1	50,0
250	4,0	62,5	5,7	62,5	8,1	62,5	9,7	62,5
300	4,0	75,0	6,5	75,0	9,4	75,0	11,3	75,0
350	4,5	87,5	7,3	87,5	10,7	87,5	12,9	87,5
400	5,0	100,0	8,1	100,0	11,9	100,0	14,5	100,0
450	5,5	112,5	8,9	112,5	13,2	112,5	16,1	112,5
500	6,0	125,0	9,7	125,0	14,5	125,0	17,7	125,0
550	6,5	137,5	10,5	137,5	15,8	137,5	19,3	137,5
600	7,0	150,0	11,3	150,0	17,1	150,0	20,9	150,0
700	8,1	175,0	12,9	175,0	19,6	175,0	24,1	175,0

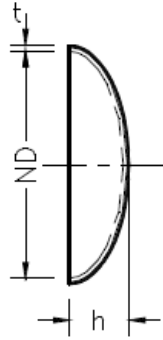

DN [mm]	PN6		PN10		PN16		PN20	
	t [mm]	h [kg/m]	t [mm]	h [kg/m]	t [mm]	h [kg/m]	t [mm]	h [kg/m]
750	8,6	187,5	13,7	187,5	20,9	187,5	25,7	187,5
800	9,1	200,0	14,5	200,0	22,2	200,0	27,3	200,0
900	10,1	225,0	16,1	225,0	24,7	225,0		
1000	11,1	250,0	17,7	250,0	27,3	250,0		
1100	12,1	275,0	19,3	275,0	29,9	275,0		
1200	13,1	300,0	20,9	300,0	32,4	300,0		
1300	14,1	325,0	22,5	325,0	35,0	325,0		
1400	15,1	350,0	24,1	350,0	37,5	350,0		
1500	16,1	375,0	25,7	375,0	40,1	375,0		
1600	17,1	400,0	27,3	400,0				
1700	18,1	425,0	28,9	425,0				
1800	19,1	450,0	30,5	450,0				
2000	21,1	500,0	33,7	500,0				

Kappe

Bezeichnung: Kappe
 Verbindung: glatte Enden zum Laminieren
 System: Vinylester
 Nennweiten: DN 25 - 2000
 Steifigkeit: SN 1250, SN 2500, SN 5000, SN 10000

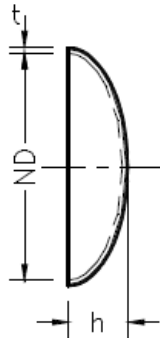

DN	SN 1250		SN 2500		SN 5000		SN 10000	
	t	h	t	h	t	h	t	h
[mm]	[mm]	[kg/m]	[mm]	[kg/m]	[mm]	[kg/m]	[mm]	[kg/m]
25	4,0	6,3	4,0	6,3	4,0	6,3	4,0	6,3
40	4,0	10,0	4,0	10,0	4,0	10,0	4,0	10,0
50	4,0	12,5	4,0	12,5	4,0	12,5	4,0	12,5
65	4,0	16,3	4,0	16,3	4,0	16,3	4,0	16,3
80	4,0	20,0	4,0	20,0	4,0	20,0	4,0	20,0
100	4,0	25,0	4,0	25,0	4,0	25,0	4,0	25,0
125	4,0	31,3	4,0	31,3	4,0	31,3	4,0	31,3
150	4,0	37,5	4,0	37,5	4,0	37,5	4,0	37,5
200	4,0	50,0	4,0	50,0	4,2	50,0	5,0	50,0
250	4,0	62,5	4,2	62,5	5,0	62,5	6,0	62,5
300	4,0	75,0	4,8	75,0	5,8	75,0	7,0	75,0
350	4,5	87,5	5,4	87,5	6,6	87,5	8,1	87,5
400	5,0	100,0	6,1	100,0	7,4	100,0	9,1	100,0
450	5,5	112,5	6,7	112,5	8,2	112,5	10,1	112,5
500	6,0	125,0	7,3	125,0	9,0	125,0	11,1	125,0
550	6,5	137,5	8,0	137,5	9,8	137,5	12,1	137,5
600	7,0	150,0	8,6	150,0	10,6	150,0	13,1	150,0
700	8,1	175,0	9,9	175,0	12,2	175,0	15,1	175,0

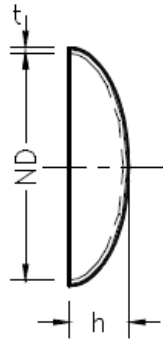

	SN 1250		SN 2500		SN 5000		SN 10000	
DN [mm]	t [mm]	h [kg/m]	t [mm]	h [kg/m]	t [mm]	h [kg/m]	t [mm]	h [kg/m]
750	8,6	187,5	10,5	187,5	13,0	187,5	16,1	187,5
800	9,1	200,0	11,2	200,0	13,8	200,0	17,1	200,0
900	10,1	225,0	12,4	225,0	15,4	225,0	19,1	225,0
1000	11,1	250,0	13,7	250,0	17,0	250,0	21,1	250,0
1100	12,1	275,0	15,0	275,0	18,6	275,0	23,2	275,0
1200	13,1	300,0	16,2	300,0	20,2	300,0	25,2	300,0
1300	14,1	325,0	17,5	325,0	21,8	325,0	27,2	325,0
1400	15,1	350,0	18,8	350,0	23,4	350,0	29,2	350,0
1500	16,1	375,0	20,0	375,0	25,0	375,0	31,2	375,0
1600			21,3	400,0	26,6	400,0	33,2	400,0
1700			22,6	425,0	28,2	425,0	35,2	425,0
1800			23,8	450,0	29,8	450,0	37,3	450,0
2000			26,4	3000,0	33,0	500,0	41,3	500,0